

## BPSY Series



### Features

- RoHS, Halogen Free and REACH Compliance
- Magnetic shielded
- Good Q factor, good energy storage and low resistance

### Applications

- Flash memory programmers
- Electric motors
- DC/DC converters

### Product Identification

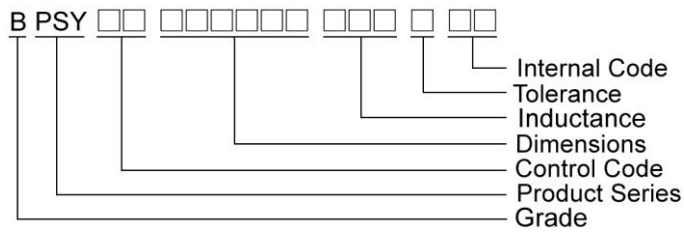

### Shape and Dimensions

BPSY00070429

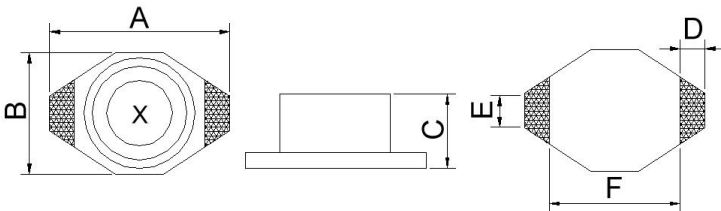

### Recommended Pattern

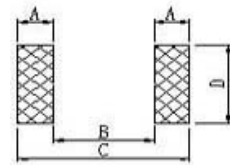

Dimensions in mm

TYPE	A	B	C	D	E	F	G
BPSY00070429	6.60 <sup>+0</sup>	4.45 <sup>+0</sup>	2.92 <sup>+0</sup>	1.02	3.05	1.27	4.32

Dimensions in mm

TYPE	A	B	C	D
BPSY00070429	1.4	4.06	6.86	3.56

# SMD Shielded Power Inductors - BPSY Series

## Shape and Dimensions

BPSY00130951

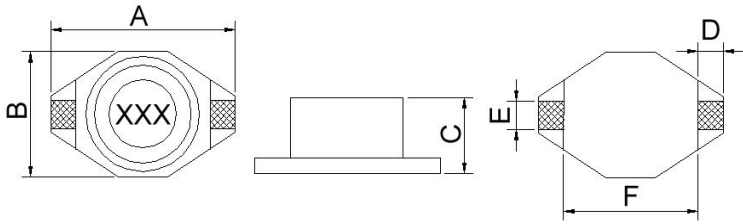

Dimensions in mm

TYPE	A	B	C	D	E	F
BPSY00130951	12.95 <sup>+0</sup>	9.40 <sup>+0</sup>	5.08 <sup>+0</sup>	2.54	2.54	7.62

## Recommended Pattern

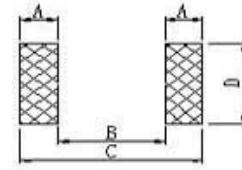

Dimensions in mm

TYPE	A	B	C	D
BPSY00130951	2.92	7.37	13.21	2.79

BPSY00191576

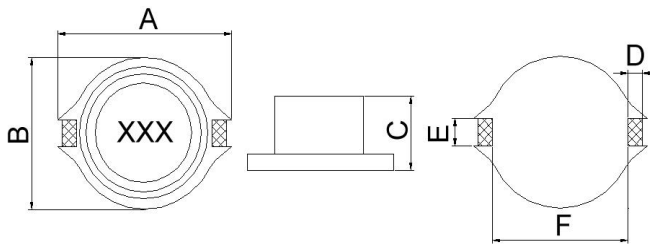

Dimensions in mm

TYPE	A	B	C	D	E	F
BPSY00191576	18.54 <sup>+0</sup>	15.24 <sup>+0</sup>	7.62 <sup>+0</sup>	2.54	2.54	12.7

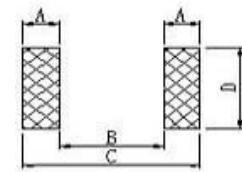

Dimensions in mm

TYPE	A	B	C	D
BPSY00191576	2.92	12.45	18.29	2.79

# SMD Shielded Power Inductors – BPSY Series

## Electrical Characteristics

Part Number	Inductance (μH)	Tolerance (±%)	Q Min	Q Frequency (kHz)	DC Resistance (Ω) Max	SRF (MHz) Typ.	I <sub>rms</sub> (A)
BPSY000704291R0M00	1.0	20	30	200	0.040	200	3.0
BPSY000704291R5M00	1.5	20	30	200	0.045	100	2.8
BPSY000704292R2M00	2.2	20	40	200	0.050	90	1.8
BPSY000704293R3M00	3.3	20	40	200	0.060	90	1.6
BPSY000704294R7M00	4.7	20	40	200	0.065	80	1.4
BPSY000704296R8M00	6.8	20	40	200	0.070	40	1.2
BPSY00070429100M00	10	20	40	200	0.075	30	1.0
BPSY00070429150M00	15	20	40	100	0.090	25	0.80
BPSY00070429220M00	22	20	40	100	0.110	20	0.70
BPSY00070429330M00	33	20	40	100	0.190	15	0.60
BPSY00070429470M00	47	20	40	100	0.230	15	0.50
BPSY00070429680M00	68	20	40	100	0.290	10	0.40
BPSY00070429101M00	100	20	40	100	0.480	8	0.30
BPSY00070429151M00	150	20	40	100	0.590	7	0.26
BPSY00070429221M00	220	20	40	100	0.770	4	0.22
BPSY00070429331M00	330	20	40	100	1.4	4	0.20
BPSY00070429471M00	470	20	40	100	1.8	3	0.19
BPSY00070429681M00	680	20	40	100	2.2	2	0.18
BPSY00070429102M00	1000	20	40	100	3.4	1	0.15

**Note: When ordering, please specify tolerance code. Tolerance: M=±20%**

- Operating temperature range - 40°C ~ 125°C(Including self - temperature rise)
- I<sub>sat</sub> for Inductance drop 30% from its value without current
- I<sub>rms</sub> for a 30°C temperature rise from 25°C ambient with current
- Measure Equipment :  
 L : E4980 or HP4284A , 100kHz/ 0.1V  
 RDC : Chroma 16502  
 I<sub>sat</sub> : HP4284A+HP42841A or WK3260B+WK3265B

## Test Instruments : HP4294A Impedance / Material Analyzer

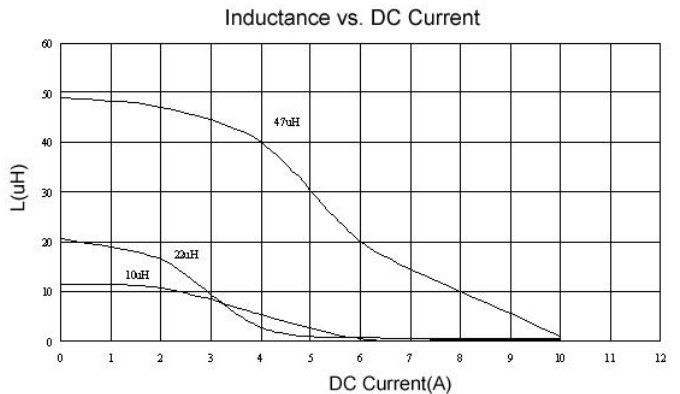
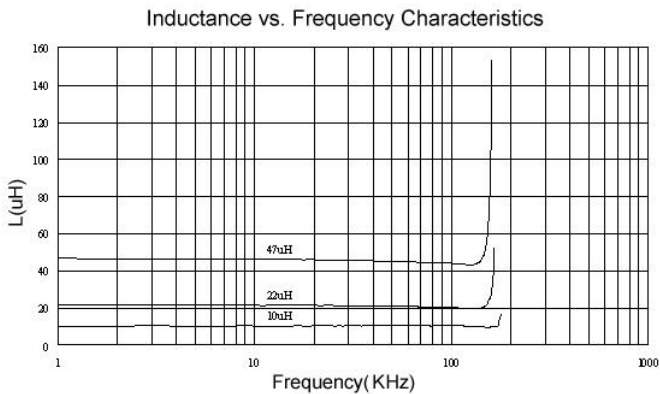

Please be sure to request approval specifications that provide further details of the products. Kindly note that the content of these specifications are subject to change or may be discontinued without prior notice. This product may not be designed/used in medical or high risk applications without Chilisin approval. Please contact our sales department before ordering.

# SMD Shielded Power Inductors – BPSY Series

## Electrical Characteristics

Part Number	Inductance (μH)	Tolerance (±%)	Q Min	Q Frequency (kHz)	DC Resistance (Ω) Max	SRF (MHz) Typ.	Isat (A)	Irms (A)
BPSY001309511R0M00	1.0	20	3	100	0.021	110	5.6	5.0
BPSY001309511R5M00	1.5	20	5	100	0.022	90	5.2	4.5
BPSY001309512R2M00	2.2	20	5	100	0.032	60	5.0	3.8
BPSY001309513R3M00	3.3	20	5	100	0.039	55	3.9	3.3
BPSY001309514R7M00	4.7	20	10	100	0.054	30	3.2	2.7
BPSY001309516R8M00	6.8	20	10	100	0.075	30	2.8	2.2
BPSY00130951100M00	10	20	10	100	0.101	28	2.4	2.0
BPSY00130951150M00	15	20	15	100	0.15	20	2.0	1.5
BPSY00130951220M00	22	20	20	100	0.207	15	1.6	1.3
BPSY00130951330M00	33	20	20	100	0.334	12	1.4	1.1
BPSY00130951470M00	47	20	20	100	0.472	10	1.0	0.8
BPSY00130951680M00	68	20			0.660	10	0.9	0.7
BPSY00130951101M00	100	20			1.110	7	0.8	0.6
BPSY00130951151M00	150	20			1.550	6	0.6	0.5
BPSY00130951221M00	220	20			2.000	5	0.5	0.37
BPSY00130951102M00	1000	20			8.300	2	0.32	0.17

**Note: When ordering, please specify tolerance code. Tolerance: M=±20%**

- Operating temperature range - 40°C ~ 125°C(Including self - temperature rise)
- Isat for Inductance drop 10% from its value without current
- I rms for a 40°C temperature rise from 25°C ambient with current
- Measure Equipment :  
 L : E4980 or HP4284A , 100kHz/ 0.1V  
 RDC : Chroma 16502  
 Isat : HP4284A+HP42841A or WK3260B+WK3265B

**Test Instruments :** HP4294A Impedance / Material Analyzer

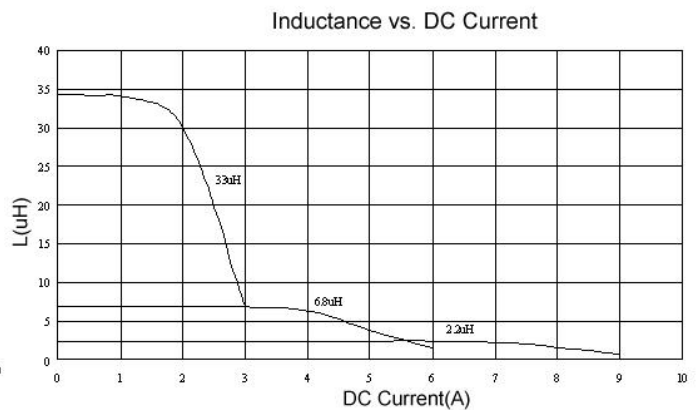
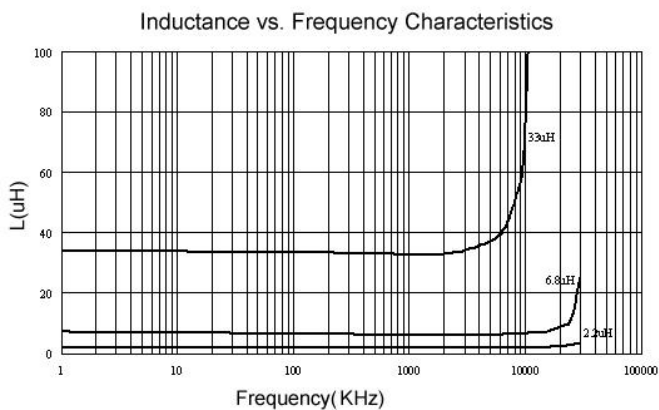

# SMD Shielded Power Inductors – BPSY Series

## Electrical Characteristics

Part Number	Inductance (μH)	Tolerance (±%)	Q Min	Q Frequency (kHz)	DC Resistance (Ω) Max	Isat (A)	Irms (A)	SRF (MHz) Typ.
BPSY00191576100M00	10	20	40	100	0.040	5.5	3.9	24
BPSY00191576150M00	15	20	40	100	0.048	4.5	3.4	16
BPSY00191576220M00	22	20	30	100	0.059	3.5	3.1	14
BPSY00191576330M00	33	20	40	100	0.075	3.3	2.8	11
BPSY00191576470M00	47	20	40	100	0.097	2.7	2.4	8.0
BPSY00191576680M00	68	20	40	100	0.140	2.2	2.0	7.0
BPSY00191576101M00	100	20	40	100	0.210	1.7	1.7	5.5
BPSY00191576151M00	150	20	50	100	0.300	1.3	1.3	4.8
BPSY00191576221M00	220	20	50	100	0.470	1.1	1.1	4.0
BPSY00191576331M00	330	20	50	100	0.780	0.86	0.86	3.0
BPSY00191576471M00	470	20	50	100	1.08	0.73	0.73	2.4
BPSY00191576681M00	680	20	60	100	1.40	0.64	0.64	2.0
BPSY00191576102M00	1000	20	60	100	2.01	0.53	0.53	1.0

**Note: When ordering, please specify tolerance code. Tolerance: M=±20%**

- Operating temperature range - 40°C ~ 125°C(Including self - temperature rise)
- Isat for Inductance drop 10% from its value without current
- Irms for a 40°C temperature rise from 25°C ambient with current
- Measure Equipment :  
 L : E4980 or HP4284A , 100kHz/ 0.1V  
 RDC : Chroma 16502  
 Isat : HP4284A+HP42841A or WK3260B+WK3265B

## Test Instruments : HP4294A Impedance / Material Analyzer

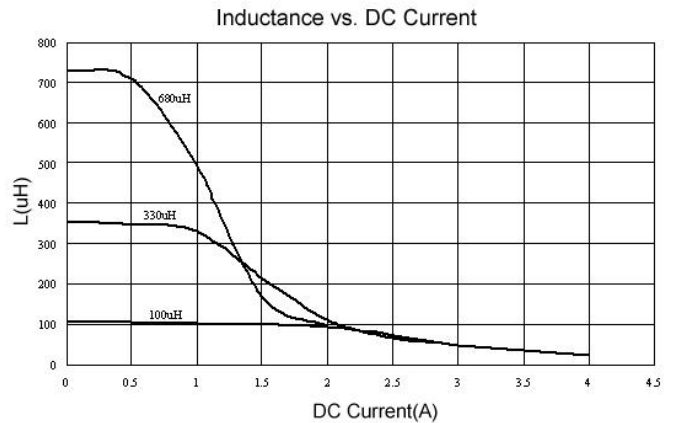
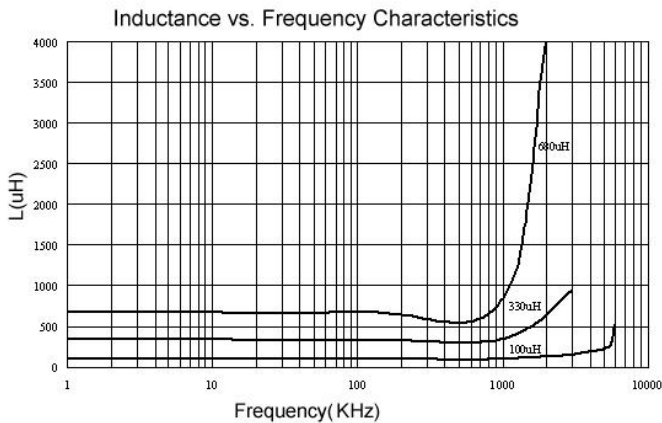

# SMD Shielded Power Inductors - BPSY Series

## Packaging Specifications

Tape Dimensions

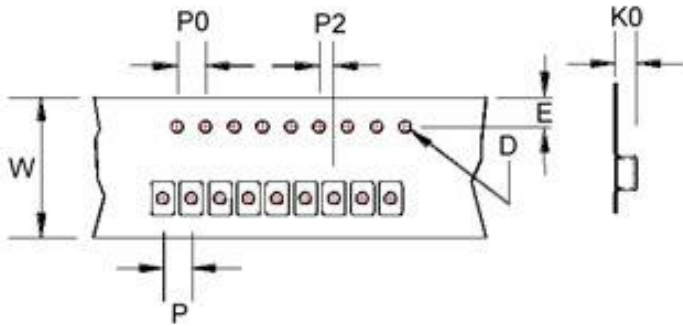

Tape Material

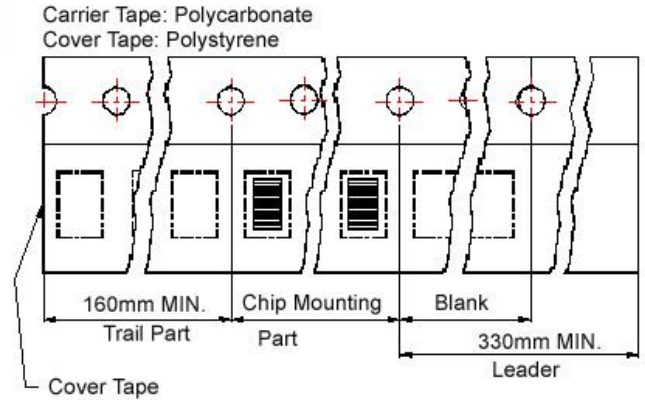

Reel Dimensions

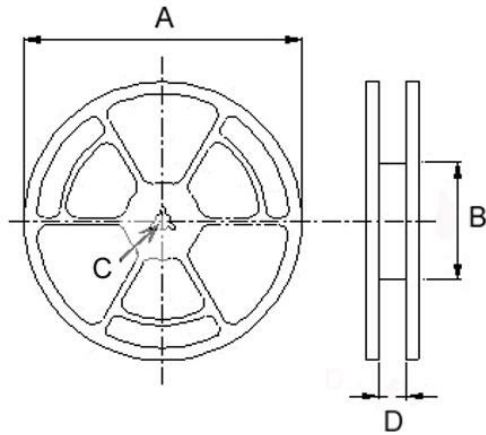

### Dimensions

TYPE	Tape Dimensions							Reel Dimensions				Quantity ( PCS / REEL )	
	K0	D	E	W	P	P0	P2	A	B	C	D	178mm	330mm
BPSY00070429	3.2	1.55	1.75	12	8	4	2	330	100	13	13.4	-	2500
								178	60		13.2	750	-
BPSY00130951	5.4	1.55	1.75	24	12	4	2	330	100	13	24.4	-	1000
BPSY00191576	7.5	1.55	1.75	32	20	4	2	330	100	13	33.4	-	250