

Absolute Maximum Rating @ Ta=25°C

Parameter	Maximum Rating	Unit
Power Dissipation	100	mW
Continuous Forward Current	30	mA
Reverse Voltage	5	V
Operating Temperature Range	-40°C to +80°C	
Storage Temperature Range	-40°C to +100°C	
Wave Soldering Profile For Lead Free Soldering	260°C for 5 sec	

Electrical / Optical Characteristic @ Ta=25°C

Parameter	Symbol	Min.	Typ.	Max.	Unit	Test Condition
Luminous Intensity	I _v	500	-	5000	mcd	I _F =20mA
Viewing Angle	2θ _{1/2}	-	55	-	deg	I _F =20mA
Forward Voltage	V _F	2.8	-	3.4	V	I _F =20mA
Reverse Current	I _R	-	-	10	μA	V _R =5V
Chromaticity Coordinates	X	0.220	-	0.296	-	I _F =20mA
	Y	0.150	-	0.305	-	I _F =20mA

* Please refer to CIE 1931 chromaticity diagram.

Bin Code List for Reference

Luminous Intensity		Unit : mcd@20mA
Bin Code	Min	Max
40	500	1000
41	1000	2000
42	2000	3000
43	3000	4000
44	4000	5000

Tolerance of Luminous Intensity on each bin is $\pm 15\%$

Forward Voltage		Unit : V@20mA
Bin Code	Min	Max
V10	2.8	3.0
V11	3.0	3.2
V12	3.2	3.4

Tolerance for each Forward Voltage Bin is $\pm 0.1V$.

Chromaticity Diagram

WA1	x	0.22	0.22	0.23	0.23	0.22
	y	0.15	0.21	0.22	0.16	0.15
WA2	x	0.23	0.23	0.24	0.24	0.23
	y	0.16	0.22	0.235	0.175	0.16
WA3	x	0.24	0.24	0.25	0.25	0.24
	y	0.175	0.235	0.25	0.19	0.175
WA4	x	0.25	0.25	0.26	0.26	0.25
	y	0.19	0.25	0.265	0.205	0.19
WA5	x	0.26	0.26	0.264	0.28	0.26
	y	0.205	0.265	0.267	0.248	0.205
WA6	x	0.28	0.264	0.283	0.296	0.28
	y	0.248	0.267	0.305	0.276	0.248

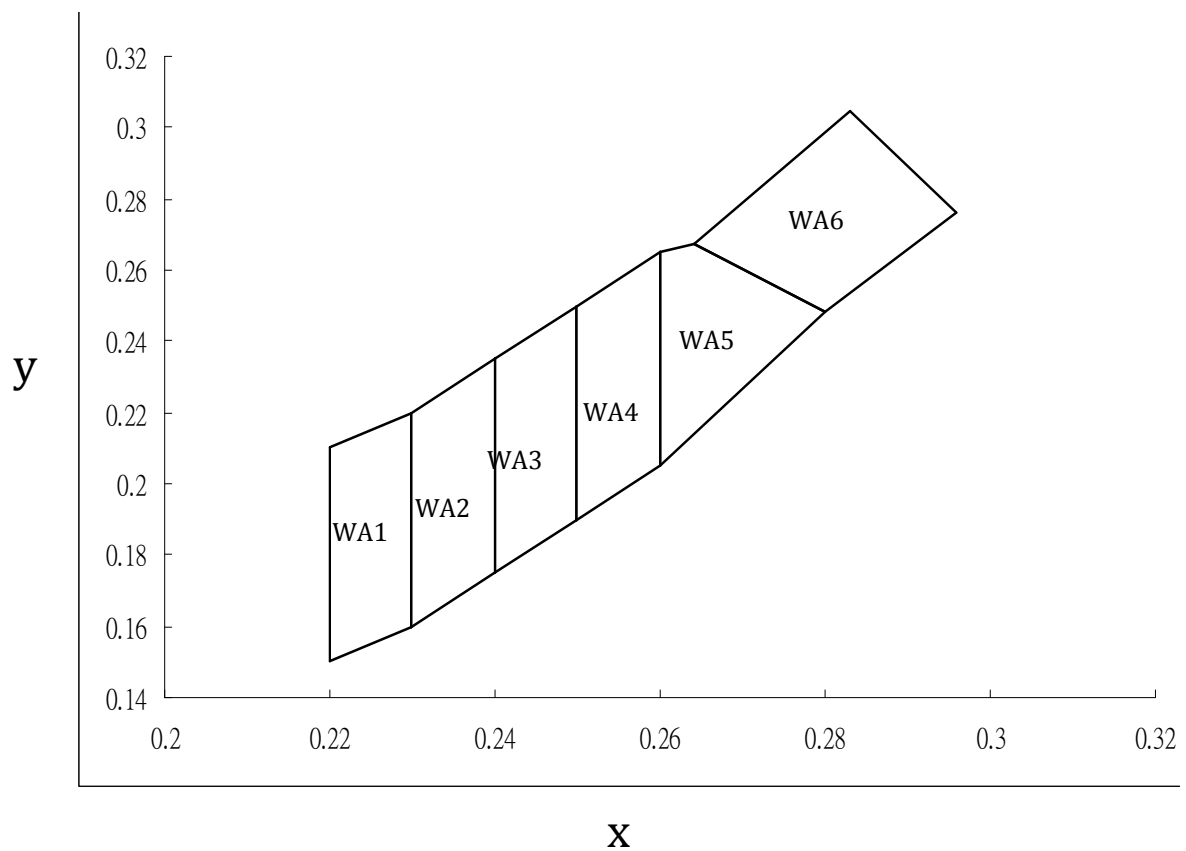

Typical Electrical / Optical Character Curves

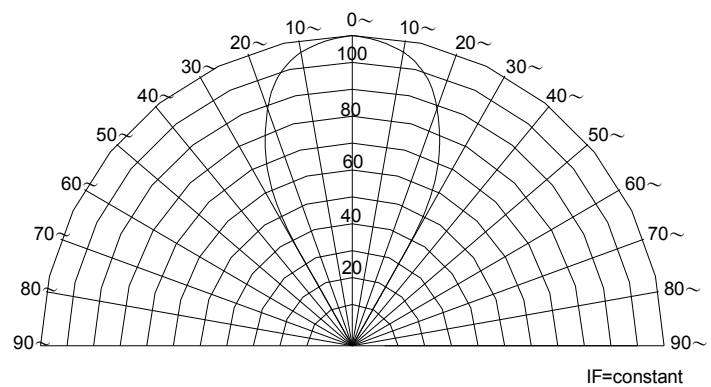
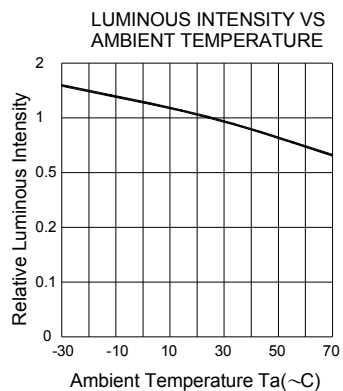
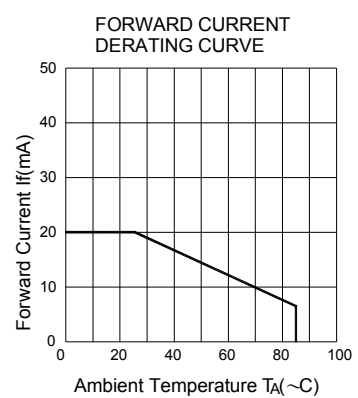
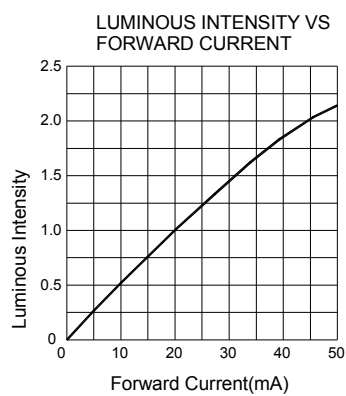
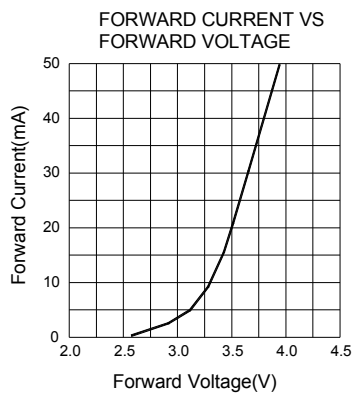
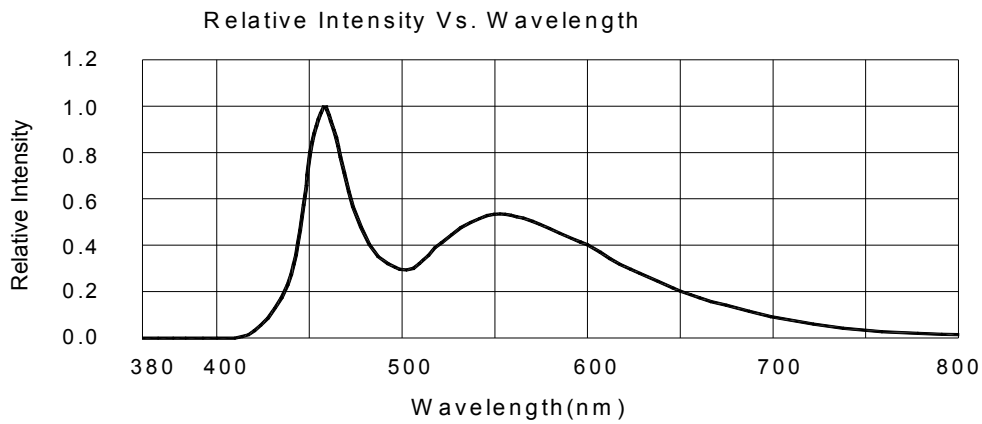

Package Description



FIG.1

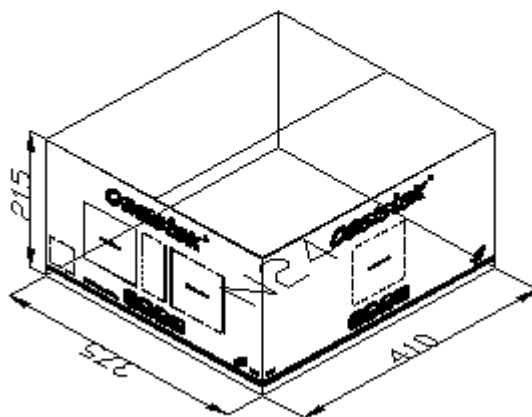
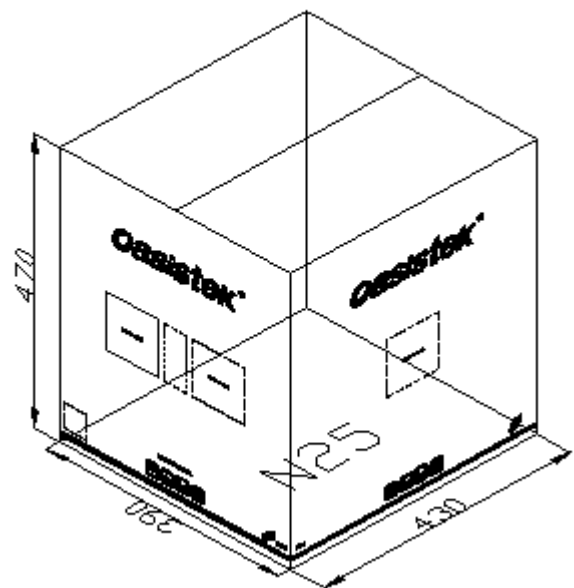

FIG.2



Reliability Test Project

Description	Item	Test criterion	Test condition	Test time	Qty	Fail Qty
Life test	Life test (Room temperature)	JIS7021:B4	Ta=25°C±5°C, IF=20mA	1000 Hrs	20	0
Ambience test	High temperature store	JIS7021:B10 MIL-STD-202:210A MIL-STD-750:2031	Ta=85°C±5°C	1000 Hrs	20	0
	Low temperature store	JIS7021:B12	Ta= -35°C±5°C	1000 Hrs	20	0
	High temperature/ humidity test	JIS7021:B11 MIL-STD-202:103D	Ta=85°C±5°C RH=85%	1000 Hrs	20	0
	Cold / Heat strike test	JIS7021::B4 MIL-STD-202:107D MIL-STD-750:1026	30min -35°C±5°C ↔ 85°C±5°C 5min	50 Cycles	20	0
	Cold and heat cycle test	JIS7021:A3 MIL-STD-202:107D MIL-STD-705:105E	5min 5min 5min -35°C~25°C~85°C~-35°C 30min 5min 30min 5min	50 Cycles	20	0

Judging criterion

Item	Symbol	Experiment condition	Criteria	
			Min.	Max.
Forward Voltage	VF	IF=20mA	-	Initial Datex1.1
Reverse Current	IR	VR=5V	-	30μA
Luminous Intensity	IV	IF=20mA	Initial Datex0.7	-

Cautions

- LED bracket forming method :
 1. The pin of led can be bent where is at least 3mm out of led colloid.
 2. Must use fixture to deform the led bracket.
 3. Finishing the forming of led bracket must be before soldering.
 4. Guarantee the gap between two pin of led tallys with LED pads in PCB when forming.
- Manual soldering :

The tip temperature of soldering iron don't exceed 260°C ; soldering time don't exceed 3s and soldering position must be 3mm out of led colloid.
- Soldering temperature curve chart (figure A、figure B) :

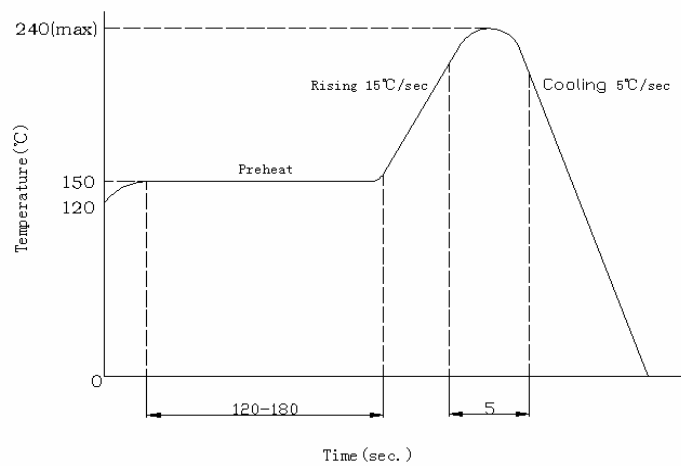
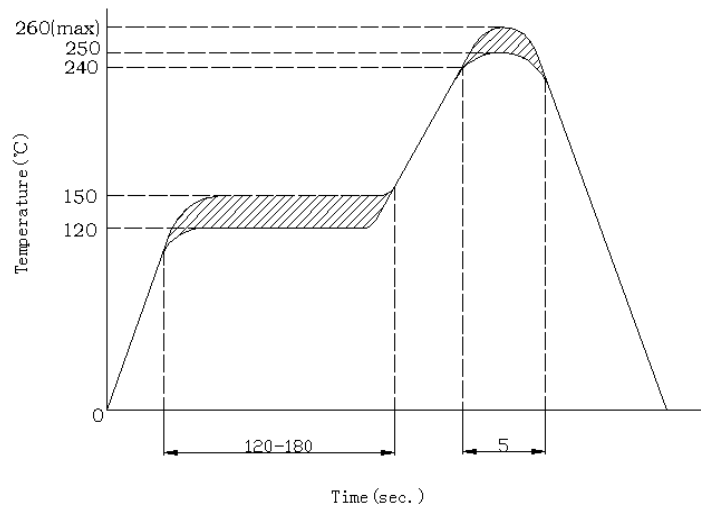

- ESD countermeasure

Static electricity and high volt can damage led. The production whose Die material is InGaN must strictly required to prevent ESD, must put on static glove and static fillet. Soldering tool and the cover of device must connect the ground, soldering condition follows the related stating of production specification manual.

- Protecting countermeasure when over current

Need add the protecting resistor in circuit in order to avoid damaging led due to big current and voltage fluctuation.

- LED installation method

1. Pay attention to the led polarity and avoid installation wrong. LED can't be close to euthermic component, work condition should tally with it's specification.
2. Don't install the LED under the condition of the led pin deformation.
3. The led bracket don't load any pressure when installing the led into PCB or fitting hole.
4. Must avoid any strike and force on led before the soldering temperature return to room temperature.

- Storage time

1. LED can be stored for a year under the condition:

the temperature of $5^{\circ}\text{C} \sim 35^{\circ}\text{C}$ and humidity of RH60%, These production must be re-inspected and tested before use if their storage time exceed a year.

2. If LED is exposed in air for a week under the condition:

the temperature of $5^{\circ}\text{C} \sim 35^{\circ}\text{C}$, humidity of RH60%, must place the led in the ambience of $65^{\circ}\text{C} \pm 5^{\circ}\text{C}$ for 24 hours and use it in 15 days for best.

- Cleaning

Be careful of some chemical results in the led colloid fades and damage when using chemical clean the LED such as chloroethylene, acetone etc. can use ethanol to wash or soak LED but the time don't exceed 3 minutes.

- Kinked

The kinked tooling scrape easily the pin of LED, where the led bracket is rusting easily, especial expose it in moist air. To decrease the led bracket rust, suggest using plated tin led bracket.