

SOT-23-3L Plastic-Encapsulate Transistors

2SA1037K TRANSISTOR (PNP)

FEATURES

- Excellent h_{FE} linearity.
- Compliments the 2SC2412K

MARKING : FQ, FR, FS

MAXIMUM RATINGS ($T_a=25^\circ\text{C}$ unless otherwise noted)

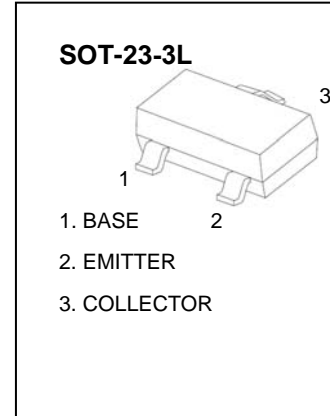

Symbol	Parameter	Value	Unit
V_{CB0}	Collector-Base Voltage	-60	V
V_{CE0}	Collector-Emitter Voltage	-50	V
V_{EB0}	Emitter-Base Voltage	-6	V
I_C	Collector Current -Continuous	-150	mA
P_C	Collector Power Dissipation	400	mW
T_J, T_{stg}	Operation Junction and Storage Temperature Range	-55-150	$^\circ\text{C}$

ELECTRICAL CHARACTERISTICS ($T_a=25^\circ\text{C}$ unless otherwise specified)

Parameter	Symbol	Test conditions	Min	Typ	Max	Unit
Collector-base breakdown voltage	$V_{(BR)CBO}$	$I_C=-50\mu\text{A}, I_E=0$	-60			V
Collector-emitter breakdown voltage	$V_{(BR)CEO}$	$I_C=-1\text{mA}, I_B=0$	-50			V
Emitter-base breakdown voltage	$V_{(BR)EBO}$	$I_E=-50\mu\text{A}, I_C=0$	-6			V
Collector cut-off current	I_{CBO}	$V_{CB}=-60\text{V}, I_E=0$			-0.1	μA
Emitter cut-off current	I_{EBO}	$V_{EB}=-6\text{V}, I_C=0$			-0.1	μA
DC current gain	h_{FE}	$V_{CE}=-6\text{V}, I_C=-1\text{mA}$	120		560	
Collector-emitter saturation voltage	$V_{CE(sat)}$	$I_C=-50\text{mA}, I_B=-5\text{mA}$			-0.5	V
Transition frequency	f_T	$V_{CE}=-12\text{V}, I_C=-2\text{mA}, f=30\text{MHz}$		140		MHz
Collector output capacitance	C_{ob}	$V_{CB}=-12\text{V}, I_E=0, f=1\text{MHz}$		4.0	5.0	pF

CLASSIFICATION OF h_{FE}

Rank	Q	R	S
Range	120 - 270	180 - 390	270 - 560

Typical Characteristics

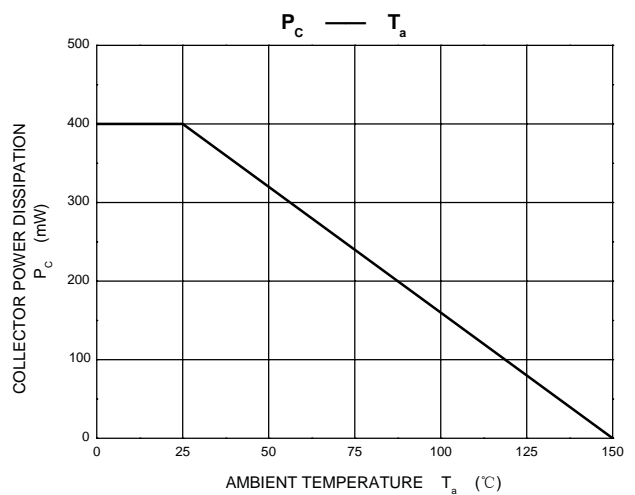
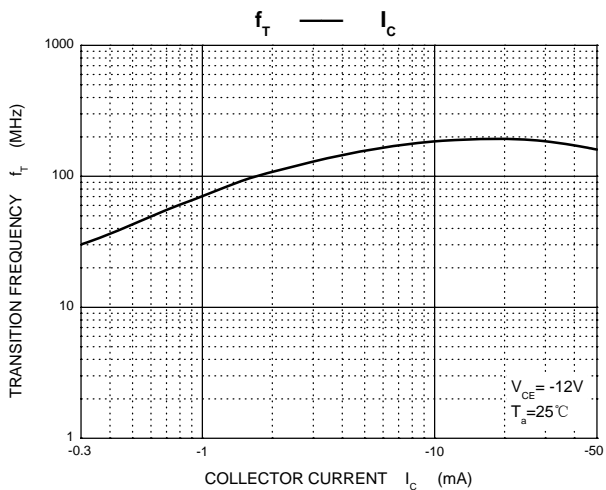
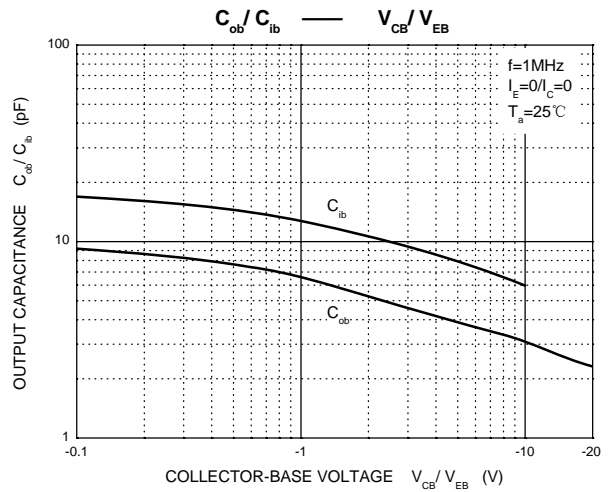
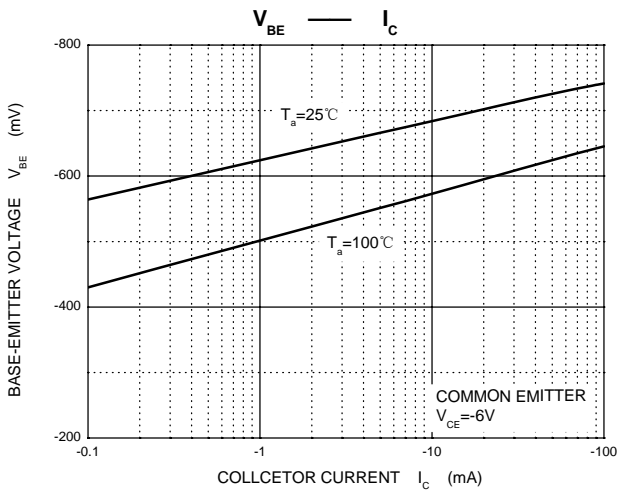
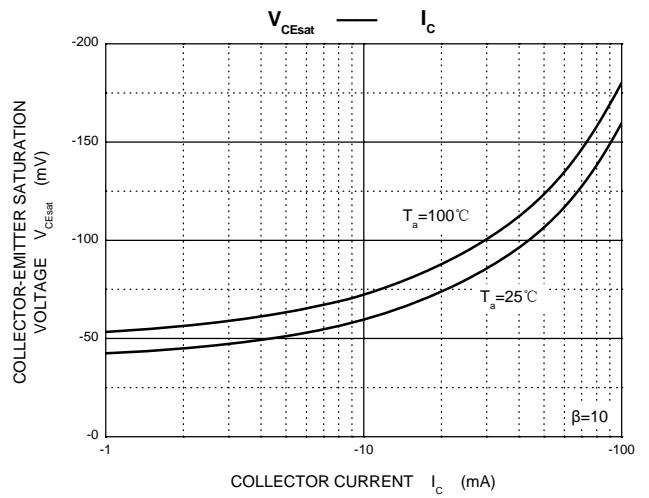
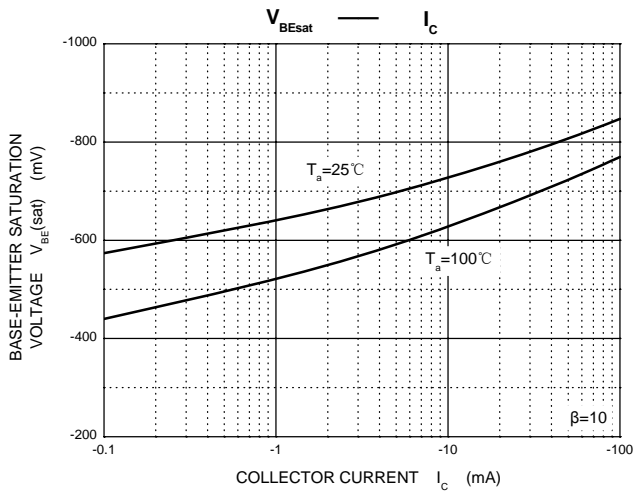
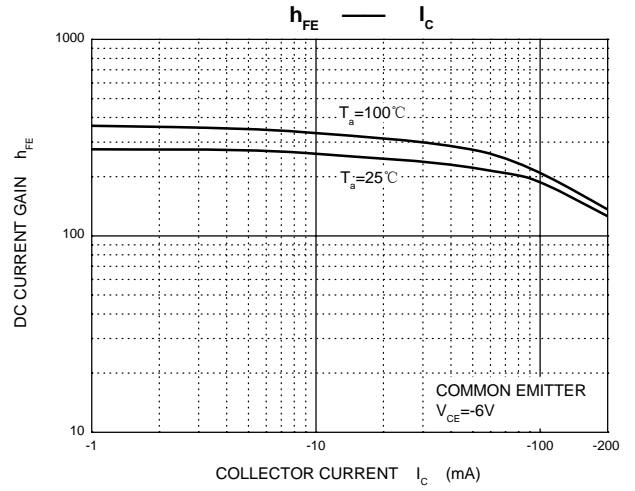
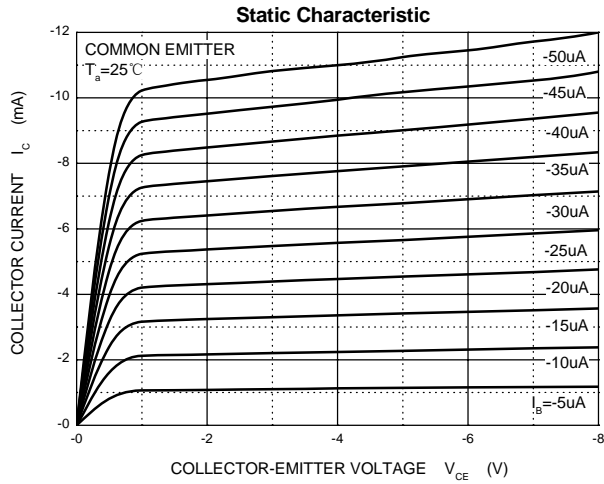

SOT-23-3L Package Outline Dimensions

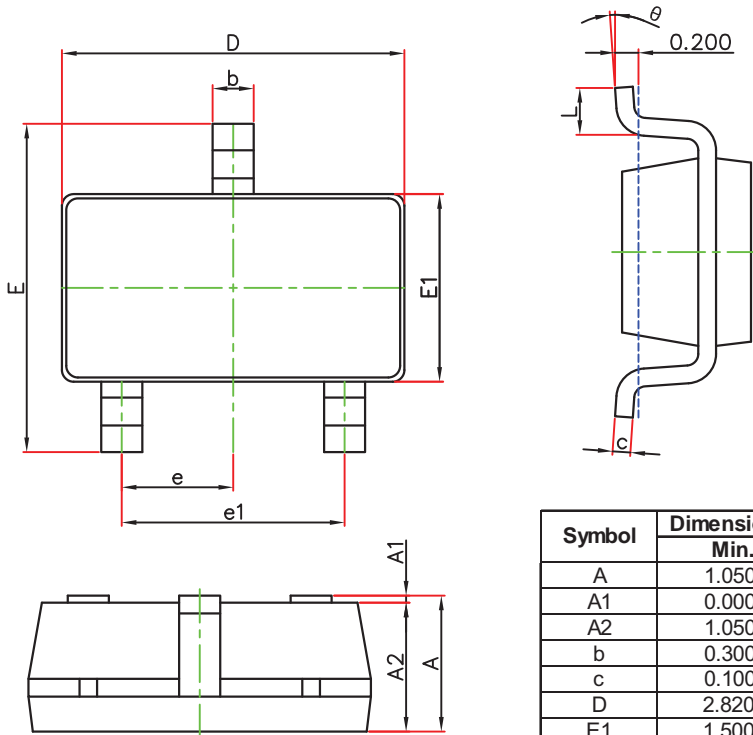

Symbol	Dimensions In Millimeters		Dimensions In Inches	
	Min.	Max.	Min.	Max.
A	1.050	1.250	0.041	0.049
A1	0.000	0.100	0.000	0.004
A2	1.050	1.150	0.041	0.045
b	0.300	0.500	0.012	0.020
c	0.100	0.200	0.004	0.008
D	2.820	3.020	0.111	0.119
E1	1.500	1.700	0.059	0.067
E	2.650	2.950	0.104	0.116
e	0.950(BSC)		0.037(BSC)	
e1	1.800	2.000	0.071	0.079
L	0.300	0.600	0.012	0.024
θ	0°	8°	0°	8°

SOT-23-3L Suggested Pad Layout

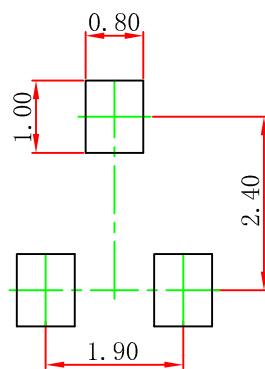

Note:

1. Controlling dimension: in millimeters.
2. General tolerance: ± 0.05 mm.
3. The pad layout is for reference purposes only.

NOTICE

JSCJ reserves the right to make modifications, enhancements, improvements, corrections or other changes without further notice to any product herein. JSCJ does not assume any liability arising out of the application or use of any product described herein.

SOT-23-3L Tape and Reel

SOT-23-3L Embossed Carrier Tape

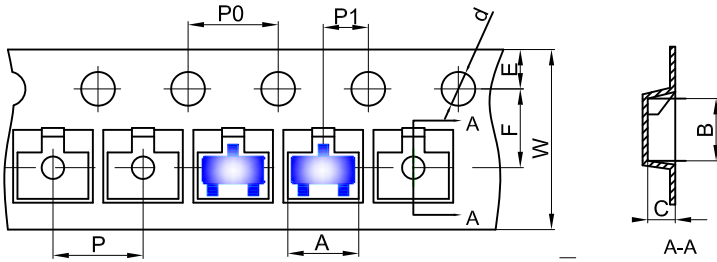

Packaging Description:

SOT-23-3L parts are shipped in tape. The carrier tape is made from a dissipative (carbon filled) polycarbonate resin. The cover tape is a multilayer film (Heat Activated Adhesive in nature) primarily composed of polyester film, adhesive layer, sealant, and anti-static sprayed agent. These reeled parts in standard option are shipped with 3,000 units per 7" or 18.0cm diameter reel. The reels are clear in color and is made of polystyrene plastic (anti-static coated).

Dimensions are in millimeter											
Pkg type	A	B	C	d	E	F	P0	P	P1	W	
SOT-23-3L	3.18	3.28	1.32	Ø1.50	1.75	3.50	4.00	4.00	2.00	8.00	

SOT-23-3L Tape Leader and Trailer

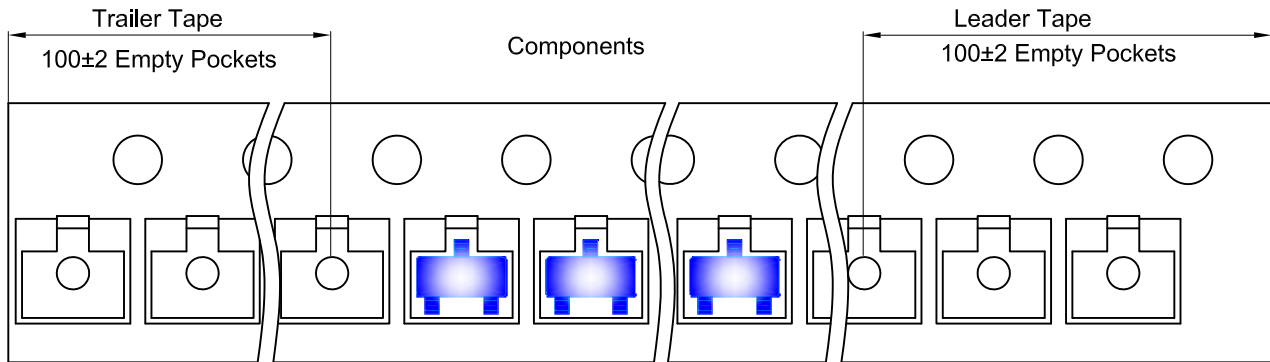

SOT-23-3L Reel

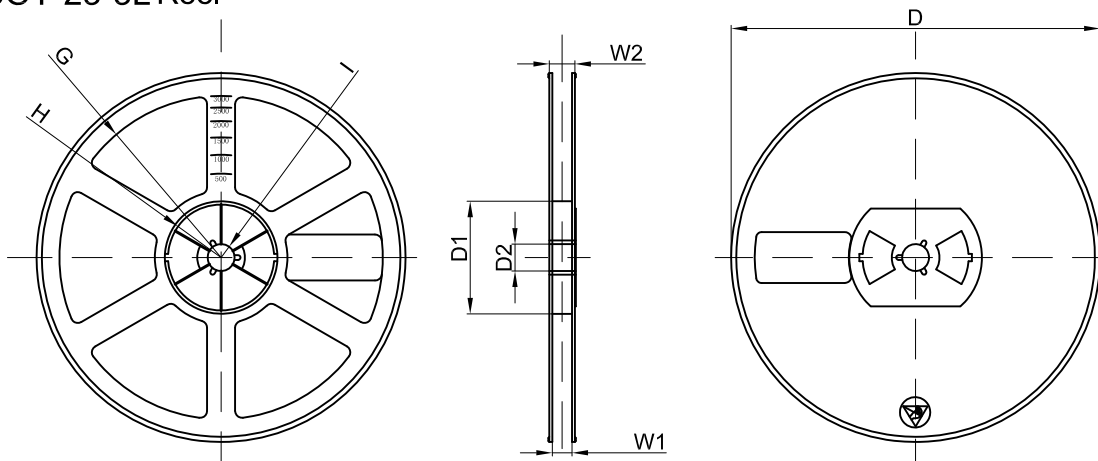

Dimensions are in millimeter								
Reel Option	D	D1	D2	G	H	I	W1	W2
7" Dia	Ø180.00	60.00	13.00	R78.00	R25.60	R6.50	9.50	13.10

REEL	Reel Size	Box	Box Size(mm)	Carton	Carton Size(mm)	G.W.(kg)
3000 pcs	7 inch	30,000 pcs	203×203×195	120,000 pcs	438×438×220	