

# TO-126 Plastic-Encapsulate Transistors

## BD440 / BD442 TRANSISTOR (PNP)

### FEATURES

- Amplifier and Switching Applications
- Complement To BD439, BD441

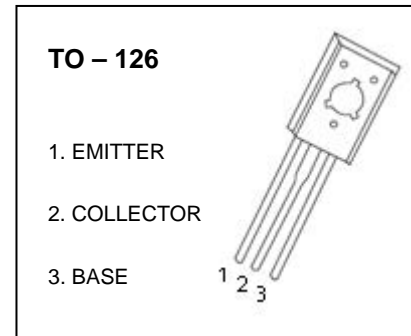

### MARKING

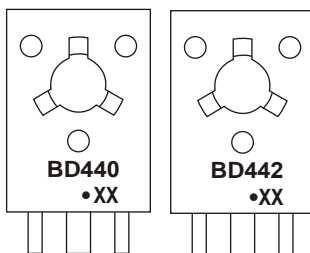

BD440, BD442 = Device code  
Solid dot = Green molding compound device, if none, the normal device  
XX = Code

### Equivalent Circuit

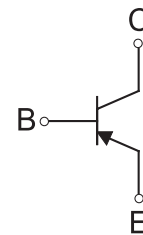

### ORDERING INFORMATION

Part Number	Package	Packing Method	Pack Quantity
BD440	TO-126	Bulk	200pcs/Bag
BD442	TO-126	Bulk	200pcs/Bag
BD440-TU	TO-126	Tube	60pcs/Tube
BD442-TU	TO-126	Tube	60pcs/Tube

### MAXIMUM RATINGS ( $T_a=25^\circ\text{C}$ unless otherwise noted)

Symbol	Parameter	Value	Units
$V_{CB0}$	Collector-Base Voltage	BD440	-60
		BD442	-80
$V_{CE0}$	Collector-Emitter Voltage	BD440	-60
		BD442	-80
$V_{EB0}$	Emitter-Base Voltage	-5	V
$I_c$	Collector Current –Continuous	-4	A
$P_c$	Collector Power Dissipation	1.25	W
$T_J, T_{stg}$	Operation Junction and Storage Temperature Range	-55-150	$^\circ\text{C}$

## ELECTRICAL CHARACTERISTICS

$T_a=25\text{ }^\circ\text{C}$

Parameter	Symbol	Test conditions	Min	Typ	Max	Unit
Collector-base breakdown voltage	$V_{(BR)CBO}$	$I_C=-100\mu\text{A}, I_E=0$ BD440 BD442	-60 -80			V
Collector-emitter breakdown voltage	$V_{CEO(SUS)}^{(1)}$	$I_C=-100\text{mA}, I_B=0$ BD440 BD442	-60 -80			V
Emitter-base breakdown voltage	$V_{(BR)EBO}$	$I_E=-100\mu\text{A}, I_C=0$	-5			V
Collector cut-off current	$I_{CBO}$	$V_{CB}=-60\text{V}, I_E=0$ $V_{CB}=-80\text{V}, I_E=0$ BD440 BD442			-100	$\mu\text{A}$
Emitter cut-off current	$I_{EBO}$	$V_{EB}=-5\text{V}, I_E=0$			-1	mA
DC current gain	$h_{FE(1)}^{(1)}$	$V_{CE}=-1\text{V}, I_C=-500\text{mA}$	40		475	
	$h_{FE(2)}^{(1)}$	$V_{CE}=-5\text{V}, I_C=-10\text{mA}$ BD440 BD442	20 15			
	$h_{FE(3)}^{(1)}$	$V_{CE}=-1\text{V}, I_C=-2\text{A}$ BD440 BD442	25 15			
Collector-emitter saturation voltage	$V_{CE(sat)}^{(1)}$	$I_C=-3\text{A}, I_B=-0.3\text{A}$			-0.8	V
Base-emitter voltage	$V_{BE}^{(1)}$	$V_{CE}=-1\text{V}, I_C=-2\text{A}$			-1.5	V
Transition frequency	$f_T$	$V_{CE}=-1\text{V}, I_C=-250\text{mA}$	3			MHz

<sup>(1)</sup>Pulse test

# Typical Characteristics

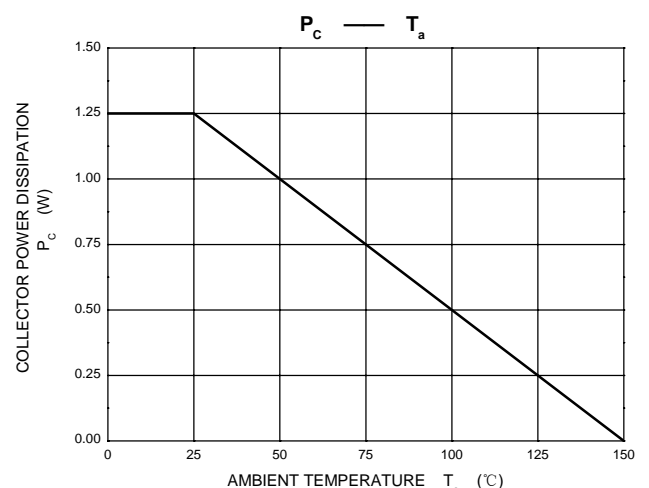
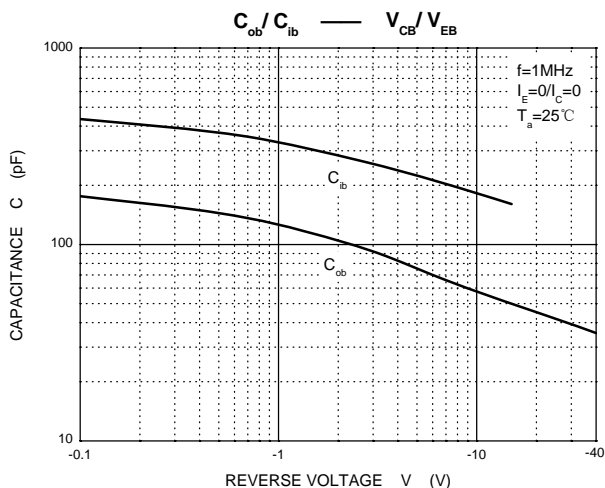
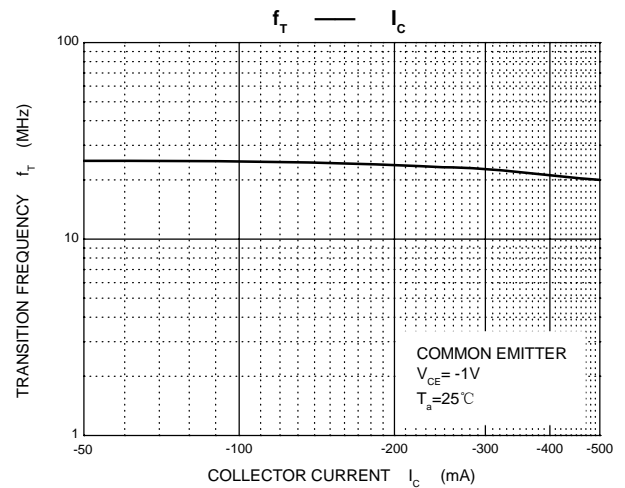
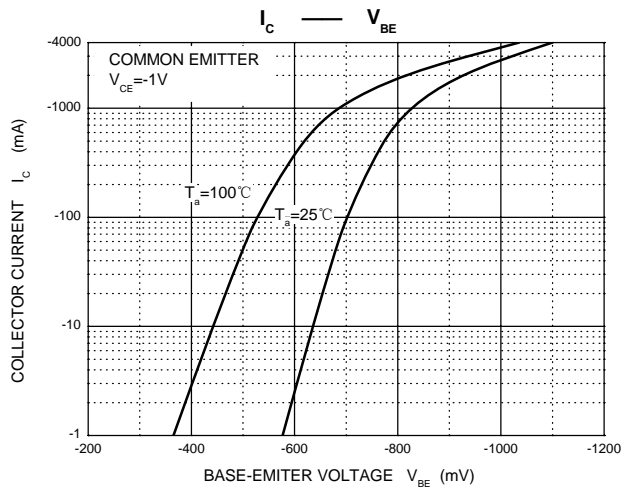
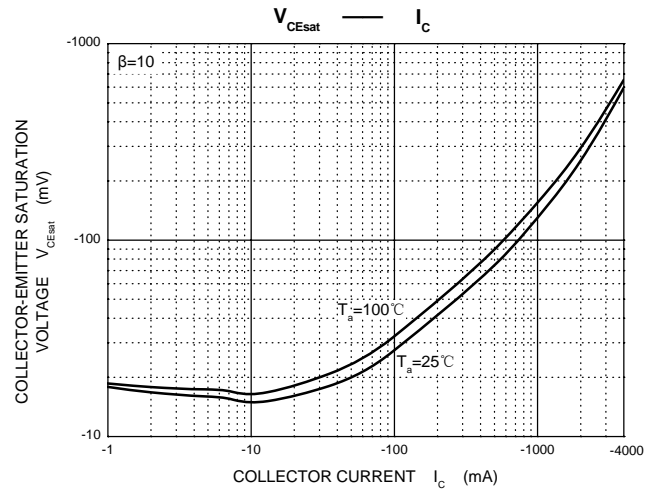
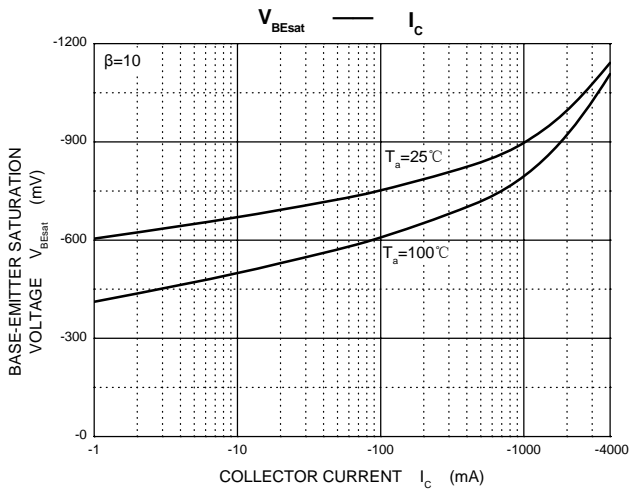
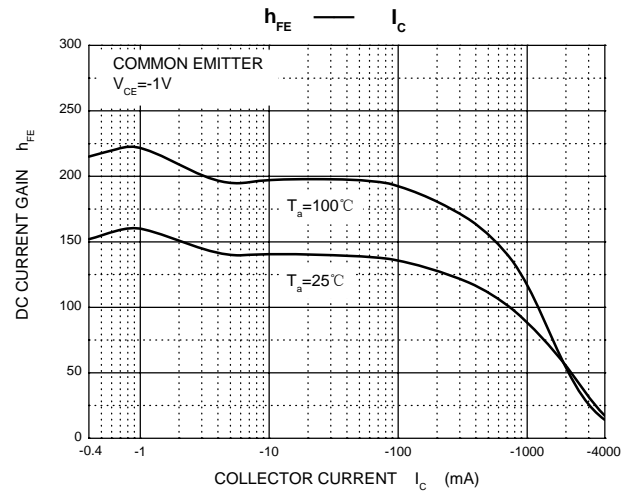
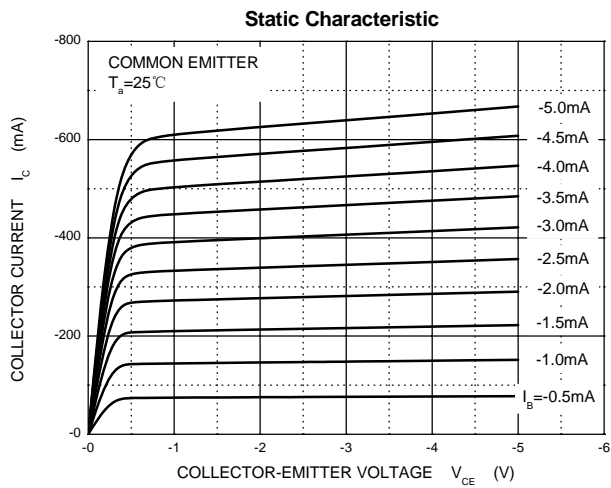

# TO-126 Package Outline Dimensions



Symbol	Dimensions In Millimeters		Dimensions In Inches	
	Min	Max	Min	Max
A	2.500	2.900	0.098	0.114
A1	1.100	1.500	0.043	0.059
b	0.660	0.860	0.026	0.034
b1	1.170	1.370	0.046	0.054
c	0.450	0.600	0.018	0.024
D	7.400	7.800	0.291	0.307
E	10.600	11.000	0.417	0.433
e	2.290 TYP		0.090 TYP	
e1	4.480	4.680	0.176	0.184
h	0.000	0.300	0.000	0.012
L	15.300	15.700	0.602	0.618
L1	2.100	2.300	0.083	0.091
P	3.900	4.100	0.154	0.161
Φ	3.000	3.200	0.118	0.126