

TITLE: 3.0 mm PITCH WTB DUAL ROW CONNECTOR

RELEASE DATE: 2019/01/26

REVISION: A

ECN No: ECN-1901407

PAGE: **2** OF **15**

1	REVISION HISTORY	3
2	SCOPE.....	4
3	APPLICABLE DOCUMENTS.....	4
4	REQUIREMENTS	4
5	PERFORMANCE.....	5
6	INFRARED REFLOW CONDITION.....	8
7	PRODUCT QUALIFICATION AND TEST SEQUENCE.....	9
8	ANATOMY OF CRIMPING TERMINAL.....	10
9	APPLICABLE WIRES: UL10368 ETFE WIRE	10
10	CRIMPING CONDITION.....	11
11	CRIMPING HEIGHT MEASUREMENT.....	12
12	PULL FORCE OF CRIMPING SECTION MEASUREMENT.....	13
13	STANDARD INSULATION CRIMPING	13
14	CONDUCTORS CRIMPING CONDITION.....	14
15	CRIMPING REQUIREMENT.....	15

TITLE: 3.0 mm PITCH WTB DUAL ROW CONNECTOR

RELEASE DATE: 2019/01/26

REVISION: A

ECN No: ECN-1901407

PAGE: 3 OF 15

1 Revision History

Rev.	ECN #	Revision Description	Prepared	Date
1	ECN-1704349	NEW DRAWING	TANGENHUI	2017/03/24
O	ECN-1712077	REVISED SPEC AND ADD 52995 SERIES	Tang,En Hui	2017/12/05
A	ECN-1901407	REVISED SPEC AND ADD 57980 /57978	Tang,En Hui	2019/01/26

TITLE: 3.0 mm PITCH WTB DUAL ROW CONNECTOR

RELEASE DATE: 2019/01/26

REVISION: A

ECN No: ECN-1901407

PAGE: 4 OF 15

2 SCOPE

This specification covers performance, tests and quality requirements for **3.0 mm pitch WTB Dual Row connector**.

3 APPLICABLE DOCUMENTS

EIA-364 ELECTRONICS INDUSTRIES ASSOCIATION

4 REQUIREMENTS

4.1 Design and Construction

4.1.1 Product shall be of design, construction and physical dimensions specified on applicable product drawing.

4.1.2 All materials conform to R.o.H.S. and the standard depends on TQ-WI-140101.

4.2 Materials and Finish

4.2.1 Contact: High performance copper alloy.

Finish: (a) Contact Area: [Refer to the drawing](#).
(b) Under plate: [Refer to the drawing](#).
(c) Solder area: [Refer to the drawing](#).

4.2.2 Housing: Thermoplastic or Thermoplastic High Temp., UL94V-0

4.2.3 Fitting Nail: [Copper Alloy](#),
Finish: [Refer to the drawing](#).

4.3 Ratings

4.3.1 Working voltage [less than 36 volts AC \(per pin\)](#)

4.3.2 Voltage: [600 Volts AC \(per pin\)](#)

4.3.3 Current and Applicable Wires : [see note](#)

Wire Gauge	Insulation Diameter	NOTES
AWG # 16~18	2.10 mm Max.	FOR 57980-Txxx-002
AWG # 20~#24	1.85 mm Max.	FOR 57958
AWG # 26~#30	1.27 mm Max.	

	Current Derating Reference Information (A)				Notes
	2 Circuits	4~6 Circuits	8~12 Circuits	14~24 Circuits	
16 AWG	9.0	7.5	6.5	6.0	FOR 57980-Txxx-002
18 AWG	8.5	7.0	6.0	5.5	
20 AWG	7	5.5	5	4.5	FOR 57958
22 AWG	6	4.5	4	3.5	
24 AWG	5.5	4.5	3.5	3	
26 AWG	4.5	4	3.5	2.5	
28 AWG	4	3	3	2	
30 AWG	3.5	3	2.5	1	

1) Values are for REFERENCE ONLY .

2) Current de-rating are based on not exceeding 30°C Temperature Rise .

3) PCB trace design can greatly affect temperature rise results in Wire-to-Board applications.

4) Data is for all circuits powered .

4.3.4 Operating Temperature : [-40°C to +105°C](#)

TITLE: 3.0 mm PITCH WTB DUAL ROW CONNECTOR

RELEASE DATE: 2019/01/26

REVISION: A

ECN No: ECN-1901407

PAGE: 5 OF 15

5 Performance

5.1. Test Requirements and Procedures Summary

Item	Requirement	Standard
Examination of Product	Product shall meet requirements of applicable product drawing and specification.	Visual, dimensional and functional per applicable quality inspection plan.
ELECTRICAL		
Item	Requirement	Standard
Low-signal Level Contact Resistance	10 m Ω Max.(initial)per contact 20 m Ω Max. Change allowed	Mate connectors, measure by dry circuit, 20mV Max., 100mA Max. (EIA-364-23)
Low-signal Level Contact Resistance of Wire Termination	5 m Ω Max.(initial)per contact 20 m Ω Max. Change allowed	Terminate the applicable wire to the terminal and measure wire using a voltage of 20mV Max., 100mA Max. (EIA-364-23)
Insulation Resistance	1000 M Ω Min.	Unmated connectors, apply 500 V DC between adjacent terminals. (EIA-364-21)
Dielectric Withstanding Voltage	No discharge, flashover or breakdown. Current leakage: 5 mA max.	1000 VAC Min. at sea level for 1 minute. Test between adjacent contacts of unmated connectors. (EIA-364-20)
Capacitance	2 pF max.	Measure between adjacent terminals at 1M Hz
Temperature rise	30°C Max. Change allowed	Mate connector: measure the temperature rise at rated current until temperature stable. The ambient condition is still air at 25°C (EIA-364-70,METHOD1,CONDITION1)
Temperature rise (via Current Cycling)	30°C Max. Change allowed	Mate connector: measure the temperature rise at rated current after : 1) 96 hours (steady state) 2) 240 hours (45 minutes ON and 15 minutes OFF per hour) 3) 96 hours (steady state) Only for the maximum number of circuits
MECHANICAL		
Durability	30 cycles.	The sample should be mounted in the tester and fully mated and unmated the number of cycles specified at the rate of 25.4 \pm 3mm/min.
Mating / Unmating Forces	Mating Force: 0.82 Kgf Max. /Per pin Unmating Force: 0.25 Kgf Min. /Per pin	Operation Speed : 25.4 \pm 3 mm/minute.. Measure the force required to mate/unmate connector. (EIA-364-13)

TITLE: 3.0 mm PITCH WTB DUAL ROW CONNECTOR

RELEASE DATE: 2019/01/26

REVISION: A

ECN No: ECN-1901407

PAGE: 6 OF 15

Contact Retention Force (Board Side)	1.40 Kgf Min.	Operation Speed : 25.4 ± 3 mm/minute. Measure the contact retention force with tester.
Crimping Terminal / Housing Retention Force (Cable Side)	2.5 Kgf MIN.	Apply axial pull out force at the speed rate of 25.4 ± 3 mm/minute. On the terminal assembled in the housing.
Crimping Terminal / Housing Insertion Force (Cable Side)	1.5 Kgf Max.	Apply an axial insertion force on the terminal at the speed rate of 25.4 ± 3 mm/minute.
Fitting Nail /Housing Retention Force	1.50 Kgf MIN.	Apply axial pull out force at the speed rate of 25.4 ± 3 mm/minute. On the fitting nail assembled in the housing.
Crimping Pull Out Force	AWG# 16~# 18 : 5.90 Kgf Min. AWG# 20 : 5.90 Kgf Min. AWG# 22 : 3.64 Kgf Min. AWG# 24 : 2.27 Kgf Min. AWG# 26 : 1.36 Kgf Min. AWG# 28 : 0.91 Kgf Min. AWG# 30 : 0.68 Kgf Min.	Operation Speed : 25.4 ± 3 mm/minute. Fix the crimped terminal, apply axial pull out force on the wire.
Thumb Latch Yield Strength	5.92 Kgf Min.	Mate loaded connectors fully. Pull connectors apart at a speed rate of 25.4 ± 3 mm/minute.
Vibration	1 μs Max.	Mate connectors and vibrate per EIA 364-28, test condition VII, Letter D. Test Duration:15 minutes each axis.
Shock (Mechanical)	1 μs Max.	Subject mated connectors to 50 G's (peak value) half-sine shock pulses of 11 milliseconds duration. Three shocks in each direction shall be applied along the three mutually perpendicular axes of the test specimen (18 shocks). The electrical load condition shall be 100mA maximum for all contacts. (EIA-364-27, test condition A)

ENVIRONMENTAL

Resistance to Wave Soldering Heat (Board Side)	See Product Qualification and Test Sequence Group 9 (Lead Free)	Solder Temp. : 265±5°C, 10±0.5sec.
Resistance to Reflow Soldering Heat (Board Side)	See Product Qualification and Test Sequence Group 9 (Lead Free)	Pre Heat : 150°C~180°C, 60~120sec. Heat : 230°C Min., 40sec Min. Peak Temp. : 260°C Max, 10sec Max. Reflow number cycle: 1 times (EIA-364-56)
Thermal Aging	See Product Qualification and Test Sequence Group 5	Subject mated connectors to temperature life at 105°C for 240 hours or 85°C for 500 hours.

TITLE: 3.0 mm PITCH WTB DUAL ROW CONNECTOR

RELEASE DATE: 2019/01/26

REVISION: A

ECN No: ECN-1901407

PAGE: 7 OF 15

Humidity	See Product Qualification and Test Sequence Group 4	Mated Connector 40°C, 90~95% RH, 96 hours. (EIA-364-31, Condition A, Method II)
Cold Resistance	See Product Qualification and Test Sequence Group 4	Subject mated connectors to temperature life at -40°C for 96 hours.
Solder ability (Board Side)	Tin plating: Solder able area shall have minimum of 95% solder coverage. Gold plating: Solder able area shall have minimum of 75% solder coverage	And then into solder bath, Temperature at 245 ±5°C, for 4-5 sec. (EIA-364-52)
Hand Soldering Temperature Resistance (Board Side)	Appearance: No damage	T ≥ 350°C, 3sec at least.

Note. Flowing Mixed Gas shall be conducted by customer request.

6 INFRARED REFLOW CONDITION

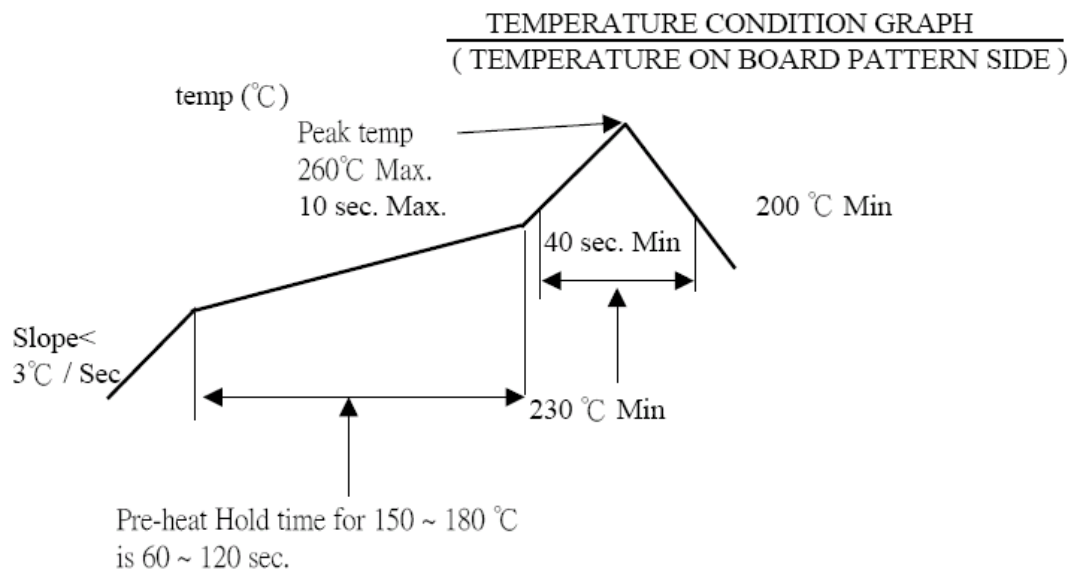

TITLE: 3.0 mm PITCH WTB DUAL ROW CONNECTOR

RELEASE DATE: 2019/01/26

REVISION: A

ECN No: ECN-1901407

PAGE: 9 OF 15

7 PRODUCT QUALIFICATION AND TEST SEQUENCE

Test or Examination	Test Group											
	1	2	3	4	5	6	7	8	9	10	11	12
	Test Sequence											
Examination of Product				1、7	1、6				1		1、5	1
Low Level Contact Resistance		1、5	1、4	2、10	2、9				3			
Insulation Resistance				3、9	3、8							
Dielectric Withstanding Voltage				4、8	4、7							
Temperature Rise	1											
Mating / Unmating Forces		2、4									4	
Durability		3										
Capacitance											2	
Thumb Latch Yield Strength												2
Contact Retention Force (Board Side)								4				
Vibration			2									
Shock (Mechanical)			3									
Thermal Aging					5							
Humidity				5								
Cold Resistance				6								
Solder ability (Board Side)						1						
Low-signal Level Contact Resistance of Wire Termination							2					
Crimping Pull Out Force							1					
Crimping Terminal / Housing Retention Force (Cable Side)								1				
Crimping Terminal / Housing Insertion Force (Cable Side)								3				
Fitting Nail / Housing Retention Force								2				
Resistance to Soldering Heat (Board Side)									2		3	
Hand Soldering Temperature Resistance (Board Side)										1		
Sample Size	2	4	4	4	4	4	4	4	4	4	4	4

8 ANATOMY OF CRIMPING TERMINAL

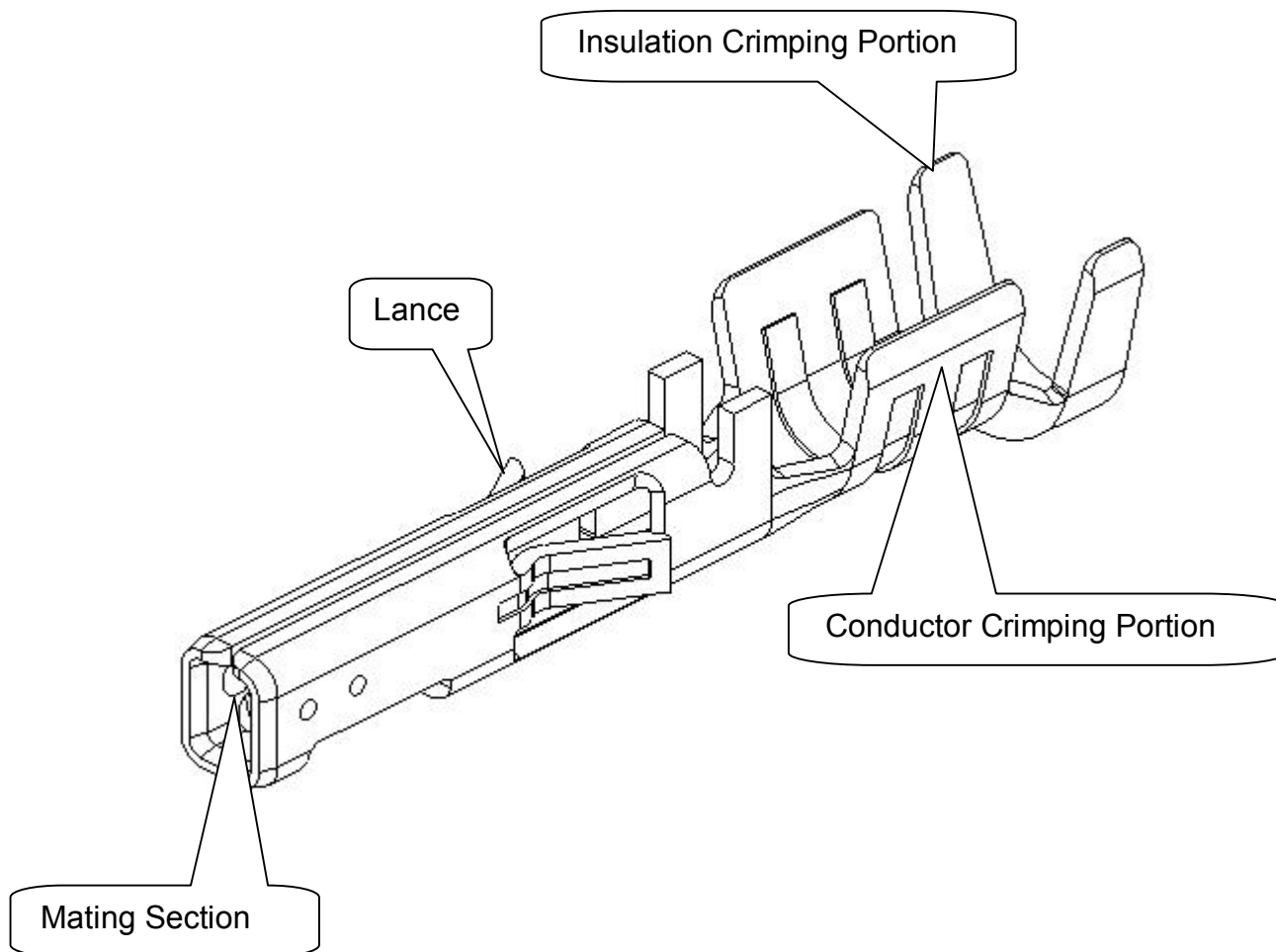

9 APPLICABLE WIRES: UL10368 ETFE WIRE

AWG Size: AWG#16~30

Insulation OD: **AWG#16** Φ 2.20mm

AWG#18 Φ 2.10mm

AWG#20 Φ 1.85mm

AWG#22 Φ 1.85mm

AWG#24 Φ 1.85mm

AWG#26 Φ 1.27mm

AWG#28 Φ 1.27mm

AWG#30 Φ 1.27mm

TITLE: 3.0 mm PITCH WT B DUAL ROW CONNECTOR

RELEASE DATE: 2019/01/26

REVISION: A

ECN No: ECN-1901407

PAGE: 11 OF 15

10 CRIMPING CONDITION**鉚線條件表 CRIMPING CONDITION**

Part Number	Wire Specification			Crimp Height (mm)		Crimp Width (mm)	
	UL Style (REF.)	AWG Size	Insulation OD(mm)	Conductor A	Insulation B	Conductor W1	Insulation W2
57958-Txxx	UL1007	20	1.85	1.1~1.35	2.0~2.2	1.7 Max.	2.1 Max.
57958-Txxx	UL1007	30	1.27	0.55~0.75	1.2~1.45	0.75 Max.	1.5 Max.
57980-Txxx-002	UL1061	16	2.20	1.80 Max.	2.45 Max.	1.8 Max.	2.45Max.

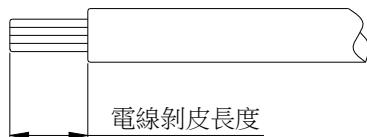

Strip length

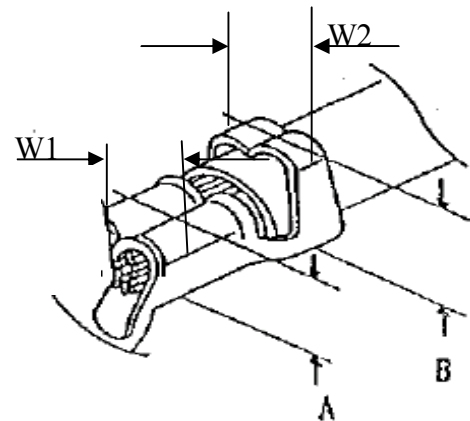

Note:

- 1、W1為芯線導體鉚壓後之寬度(Conductor Crimping Width)：W1值如上表
- 2、W2為電線外被部分鉚壓後之寬度(Insulation Crimping Width)：W2值如上表
- 3、A為芯線導體鉚壓後之高度(Conductor Crimping height)：A值如上表(參考值)
- 4、B為電線外被鉚壓後之高度(Insulation Crimping height)：B值如上表(參考值)
- 5、電線剝皮長度(Strip length)：2.5~3.0mm(參考值)

11 CRIMPING HEIGHT MEASUREMENT

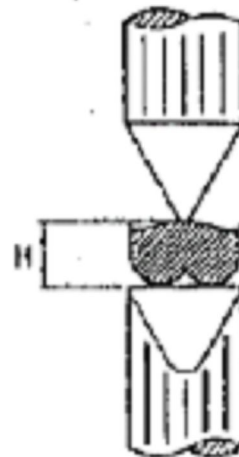
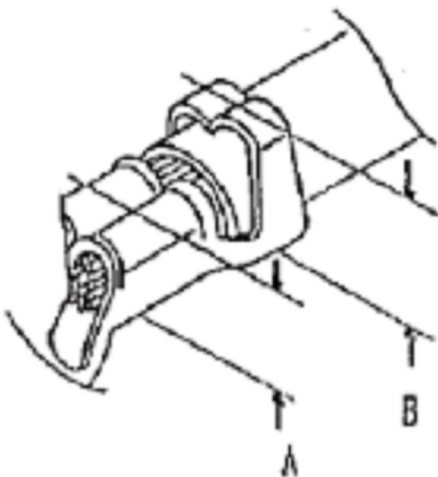
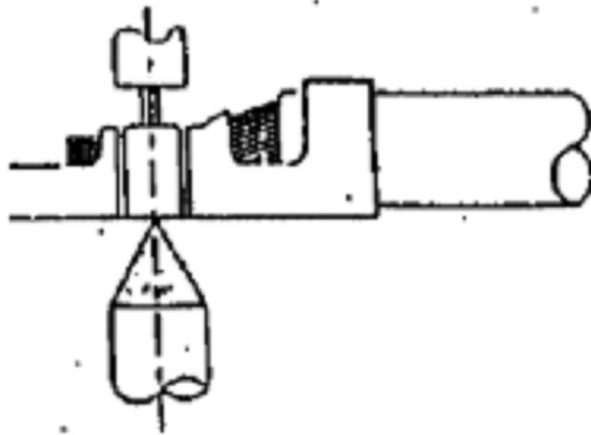
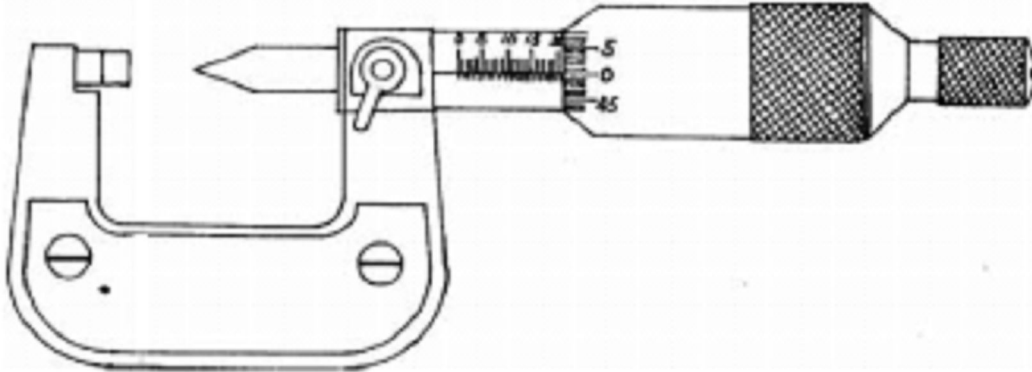

12 PULL FORCE OF CRIMPING SECTION MEASUREMENT



Before test samples, please measure crimp height and do not crimp insulation.

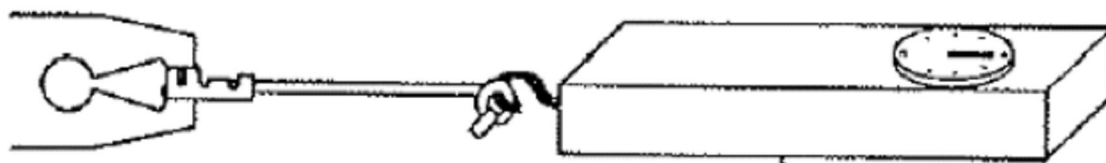

Pull Force of Crimp Section Measurement

13 STANDARD INSULATION CRIMPING

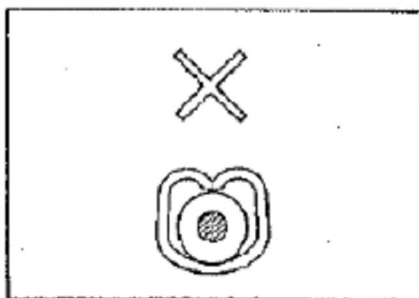

Not enough crimp

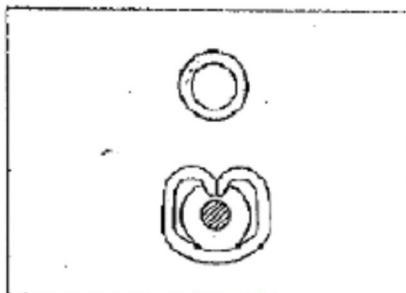

Good

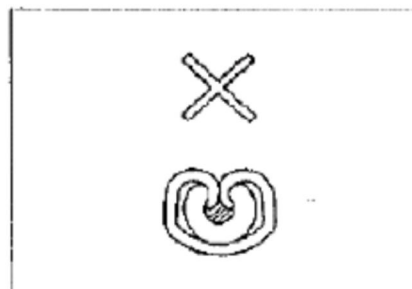

Crimp too much

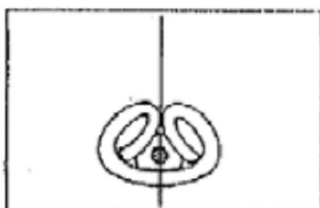

Good

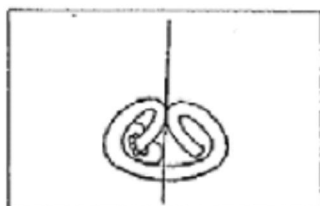

NG

Insulation Crimp Condition

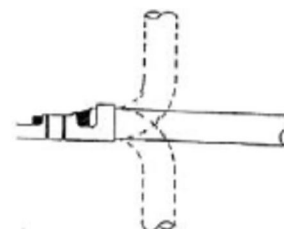

As following figure shown. It is no problem if wire bent up down 90 degrees 1 cycle and insulation position still in ideal position.

14 CONDUCTORS CRIMPING CONDITION

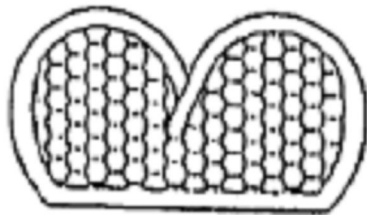
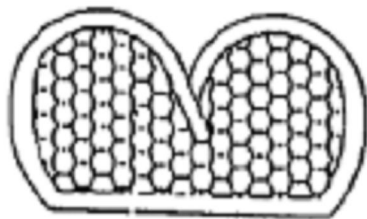
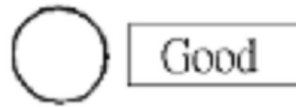
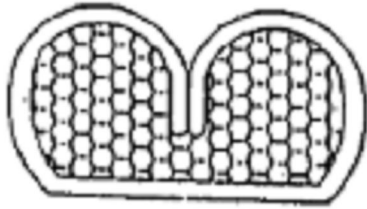

Lower conduct retention force

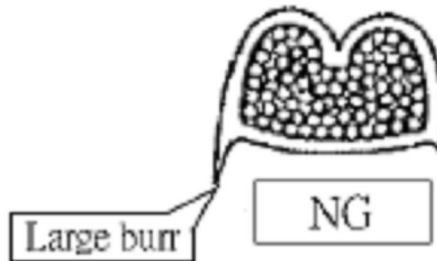

Large burr

15 CRIMPING REQUIREMENT

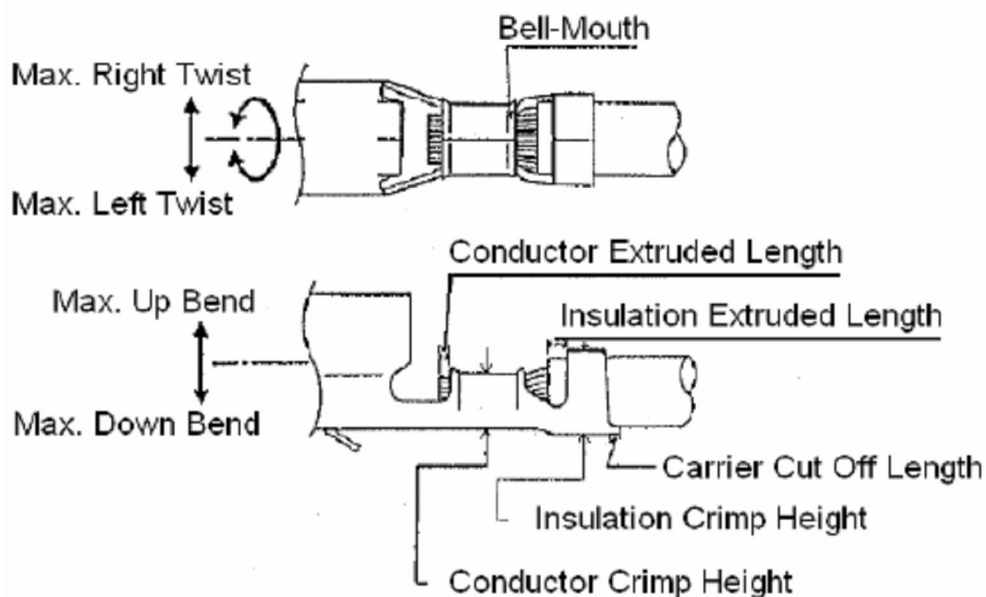

Item	Range(Ref.)
Max. Up Bend	6°
Max. Down Bend	6°
Max. Left Twist	5°
Max. Right Twist	5°
Bell-Mouth Length	0.1~0.3mm
Carrier Cut Off Length	0~0.2mm
Conductor Extruded Length	0.05~0.2mm